



**STAR  
WARS**



9494



1

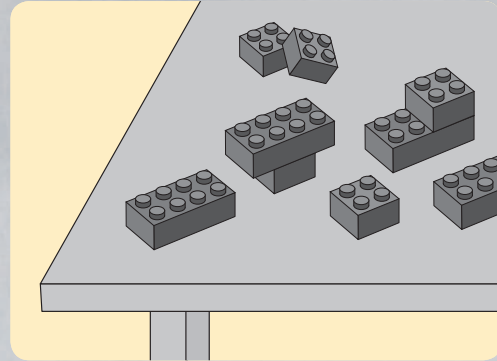
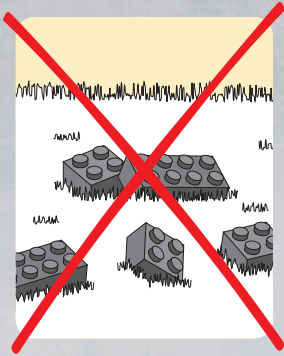

2

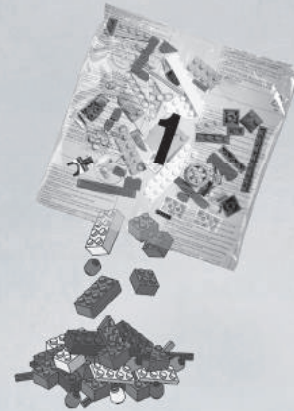
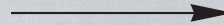

2

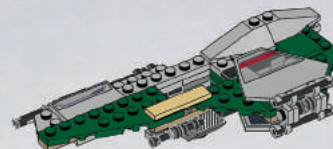
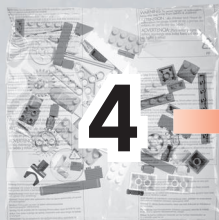
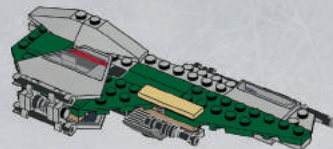
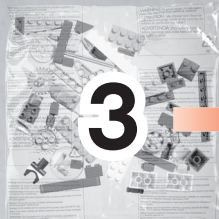
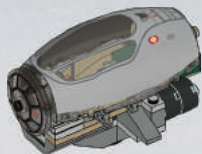
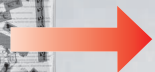
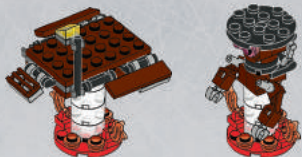

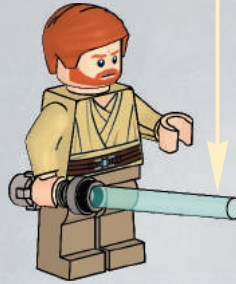
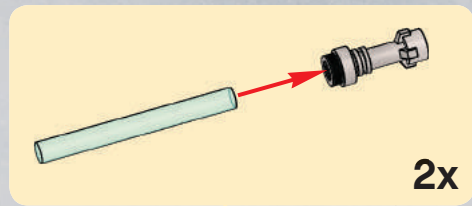
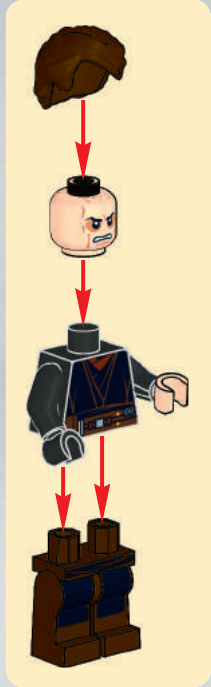

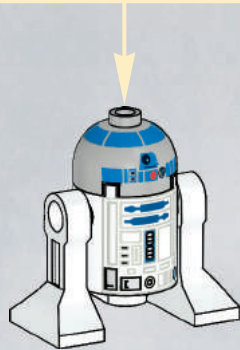
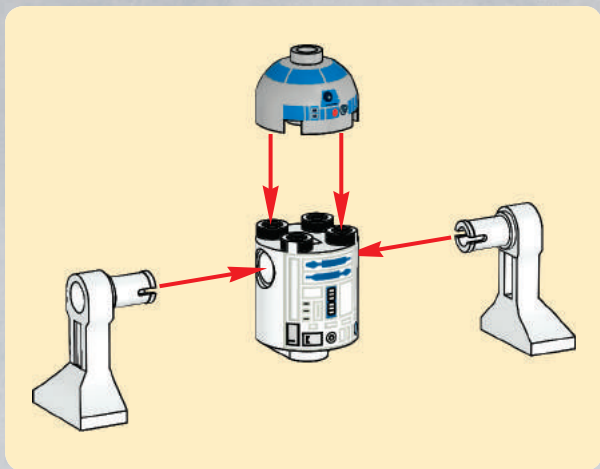
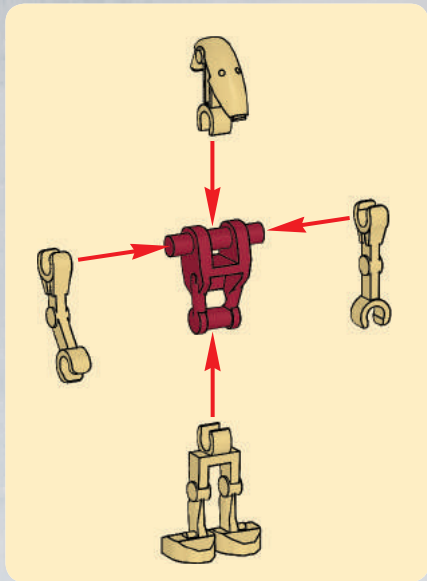



1

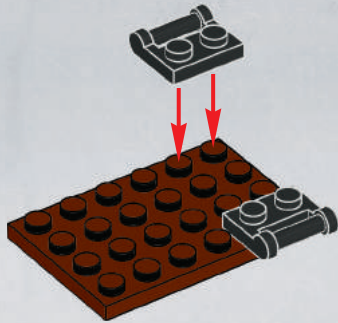

6

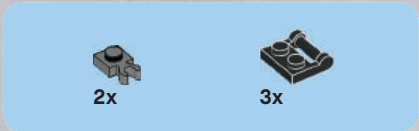

2

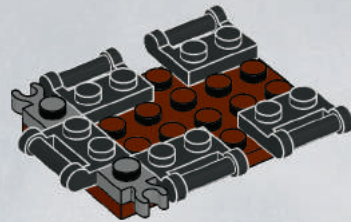



3

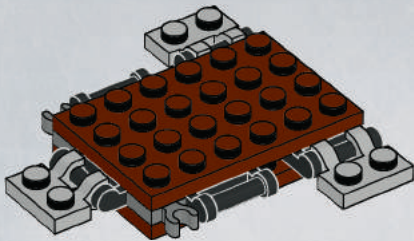

4

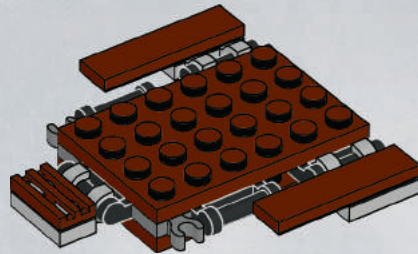

7



# 5

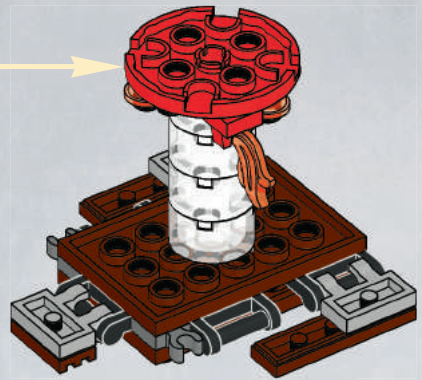
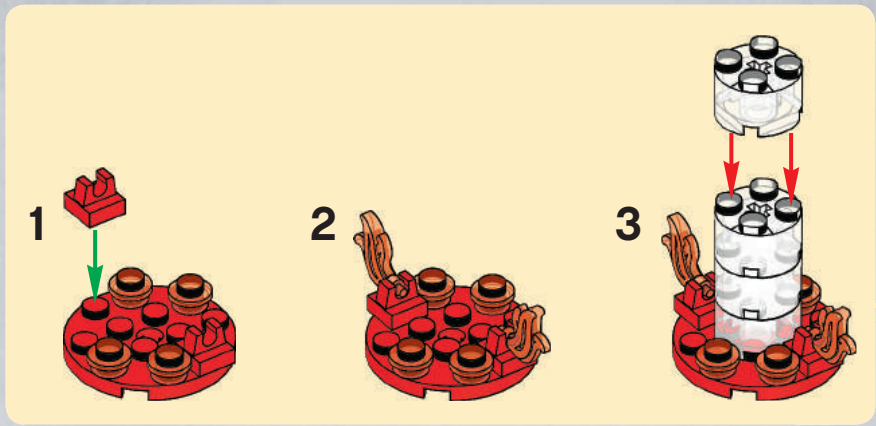

8





1x



1x



1x

# 6

1

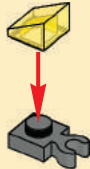

2

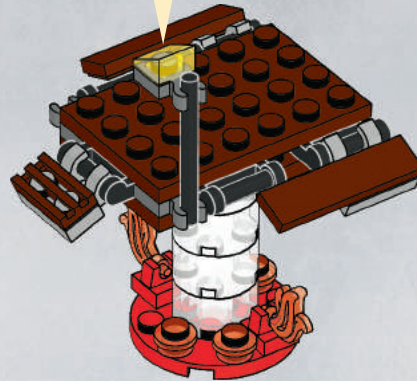

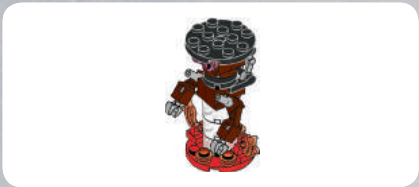

1

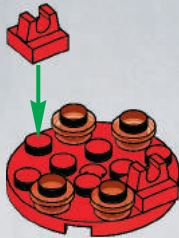

10

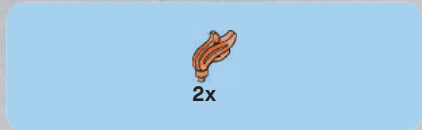

2

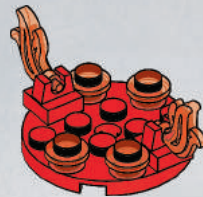



3x

3

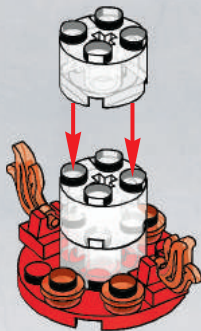

2x



1x

4

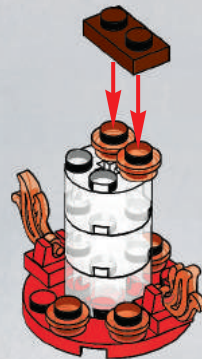



1x



2x

5

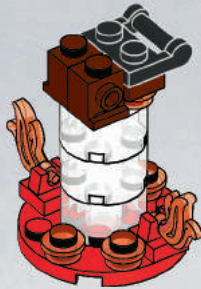

12



1x



2x

6

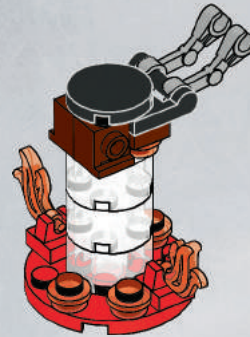



2x

# 7

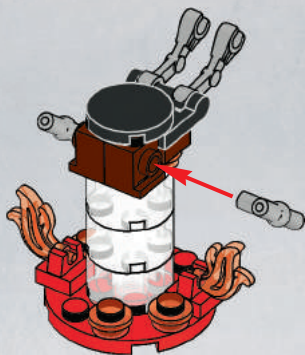

2x



2x

# 8

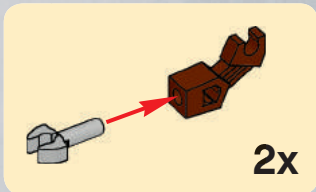

2x

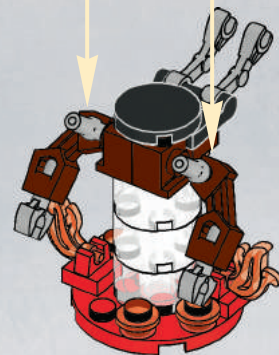

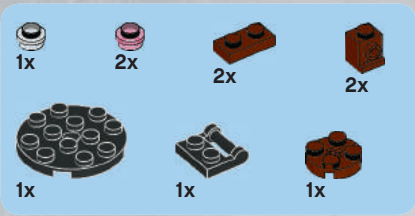

9

1

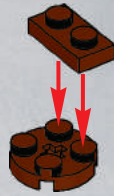

2



3



4

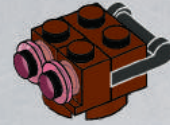

5

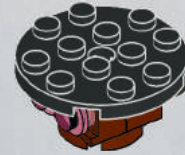

6

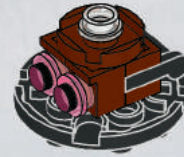

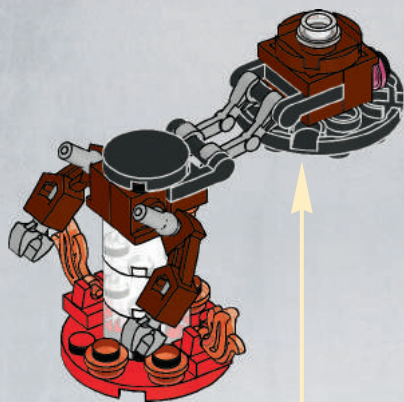

10

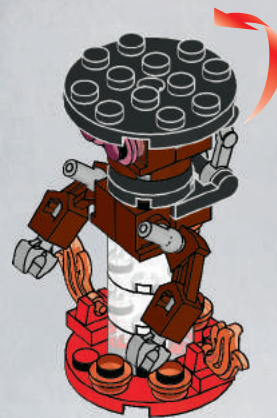

15

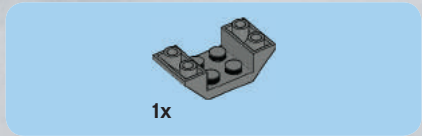
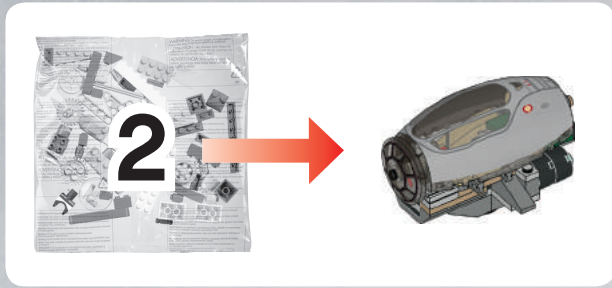

1

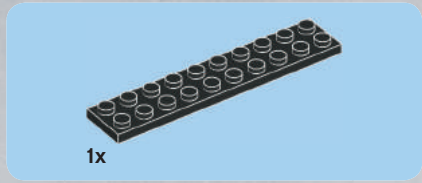
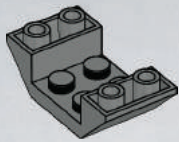

2

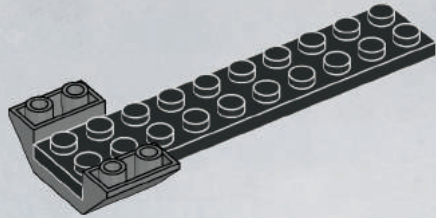



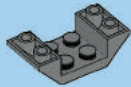

1x

3

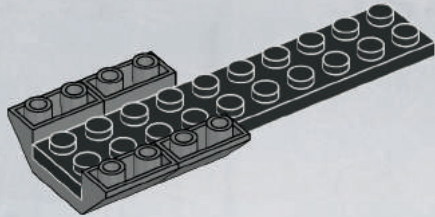

1x

4

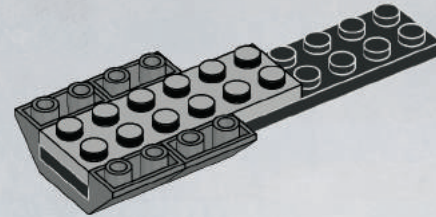

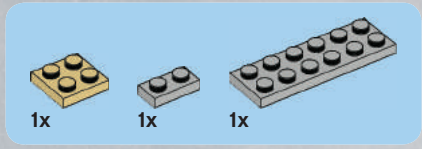

5

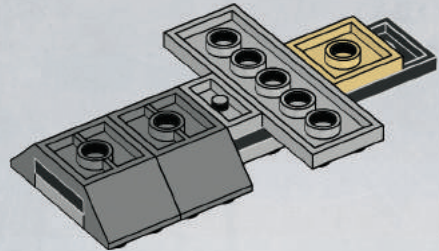

18

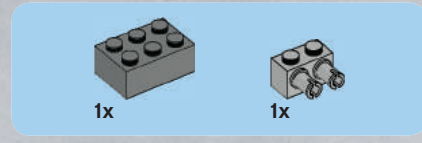

6

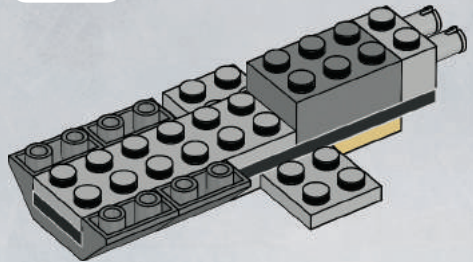



2x

7

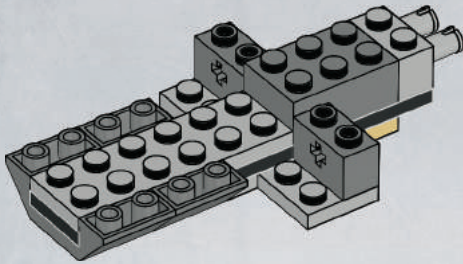

2x



2x

8

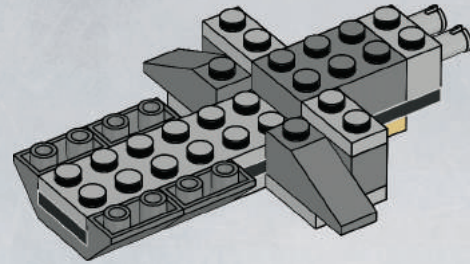

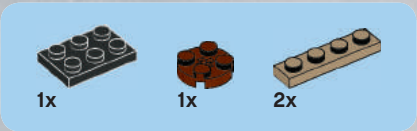

9

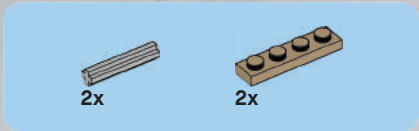
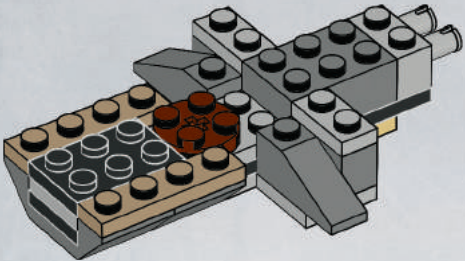

10

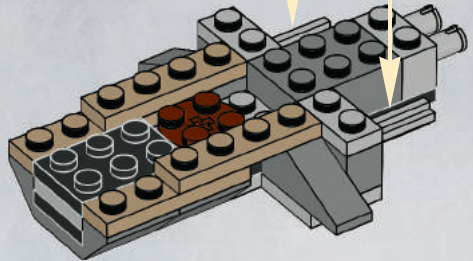

20





1x



2x



1x

# 11

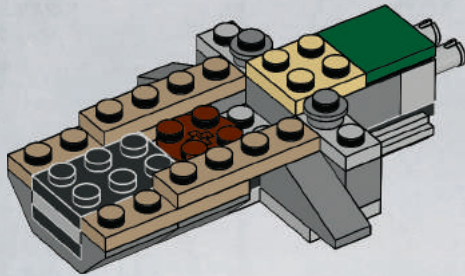

4x

# 12

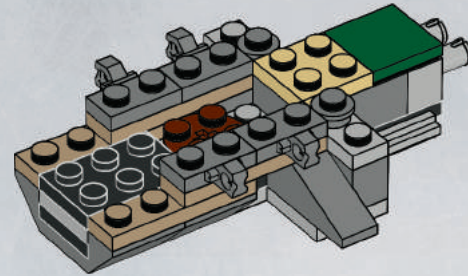



2x



1x



1x

# 13

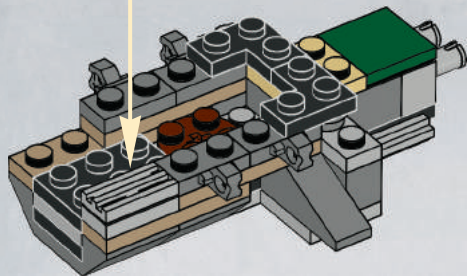
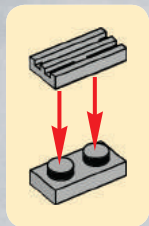

22



1x



1x

# 14

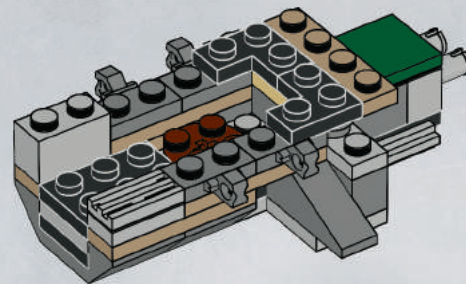



2x

# 15

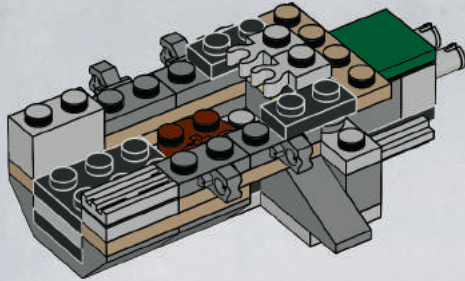

2x

# 16

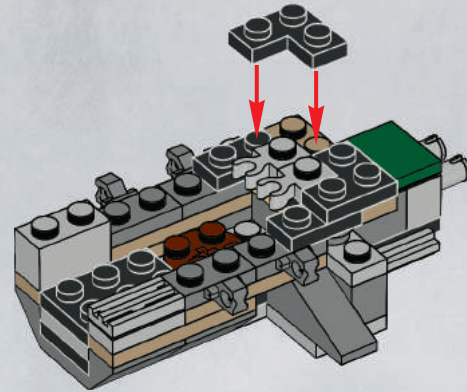



1x



2x

# 17

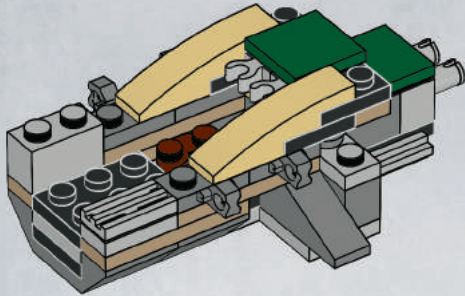

24



2x

# 18

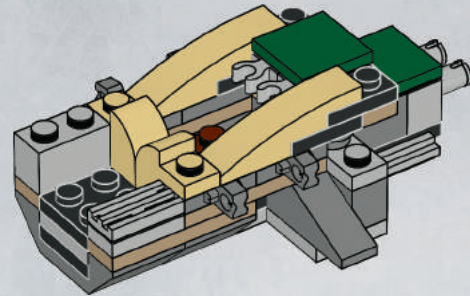



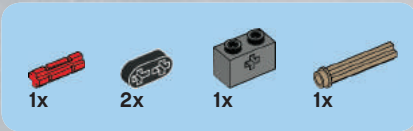

# 19

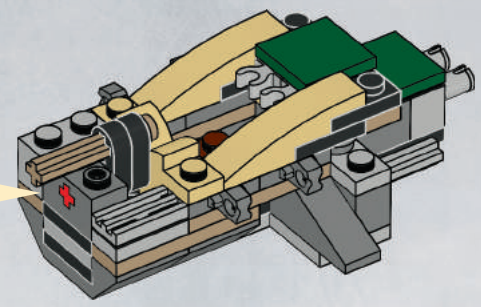
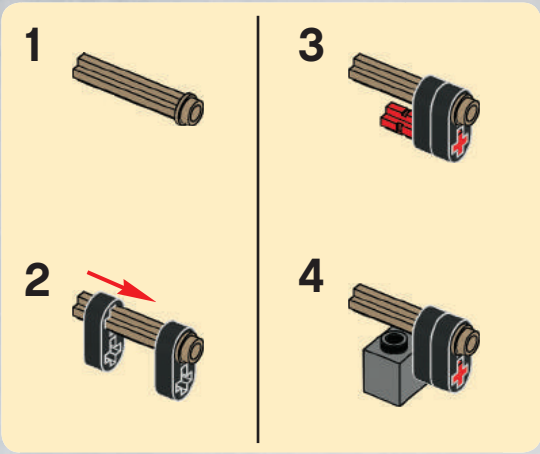

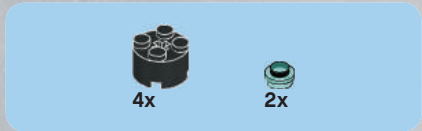

20

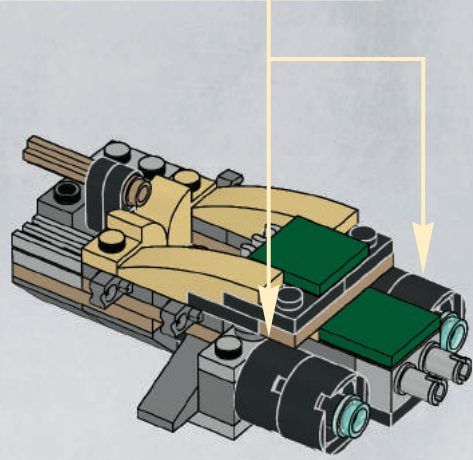
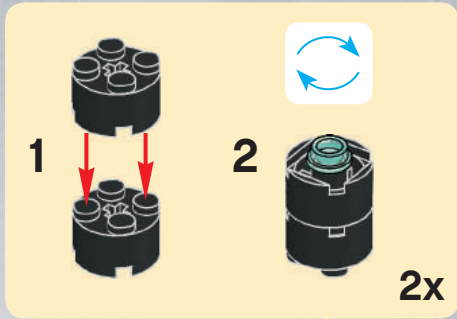

26

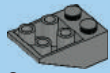

2x

# 21

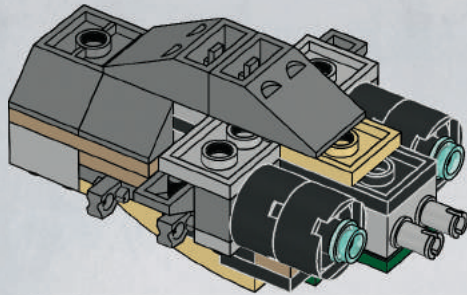

1x

# 22

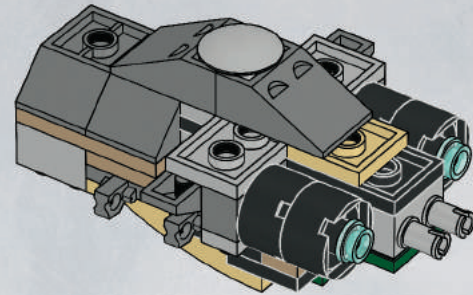

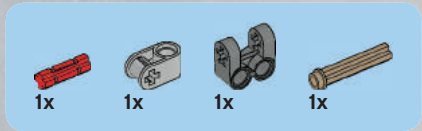

# 23

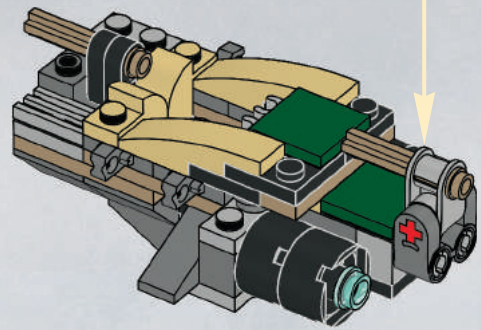
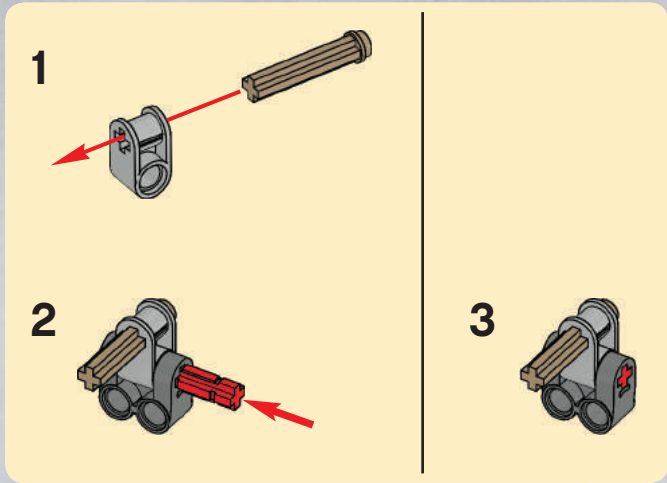



24

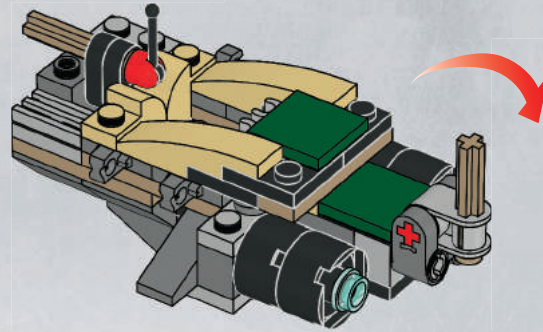

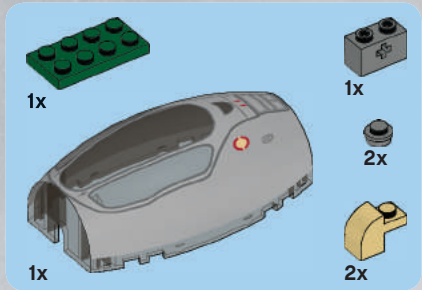

25

1

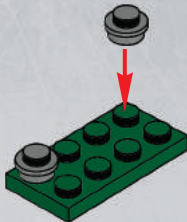

2

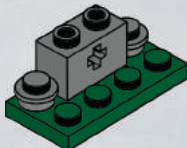

3

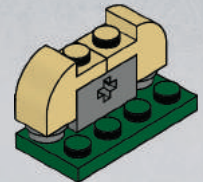

4

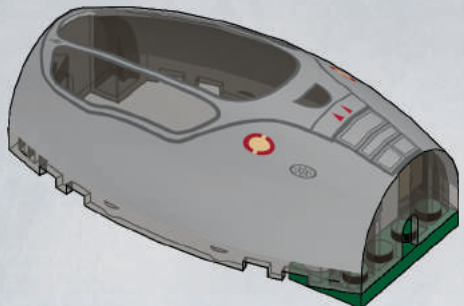

30

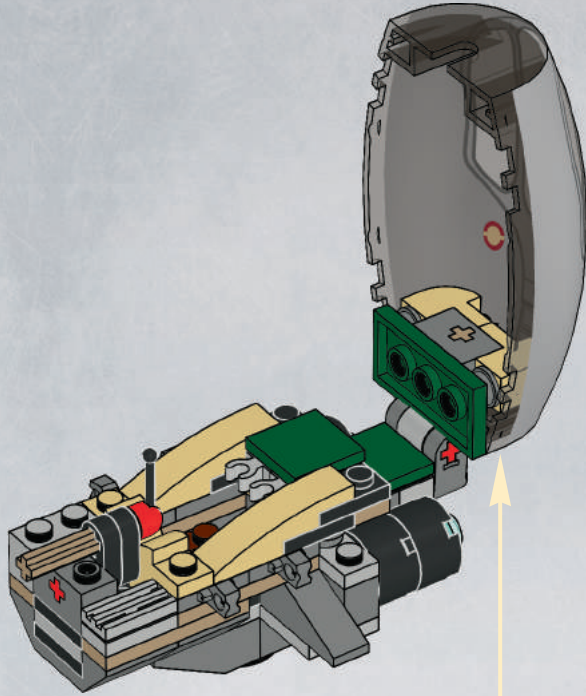

1x

26

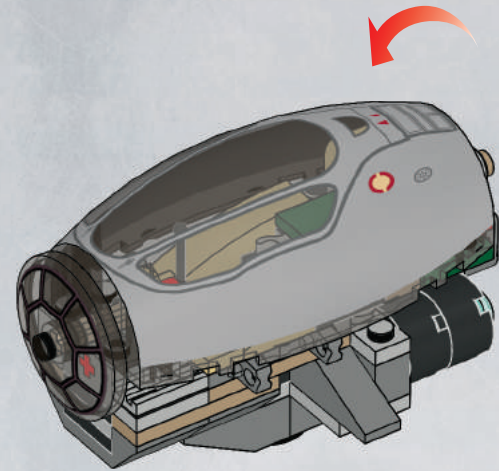

31

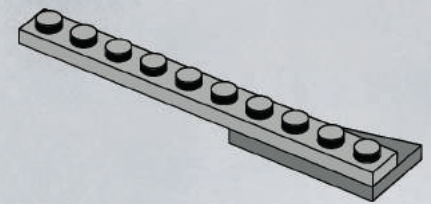
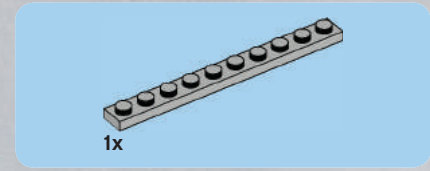
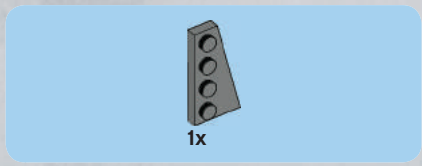
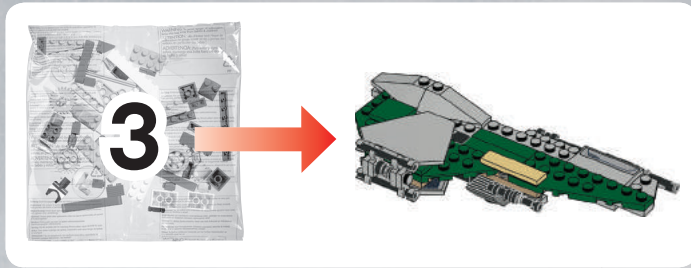





1x

3

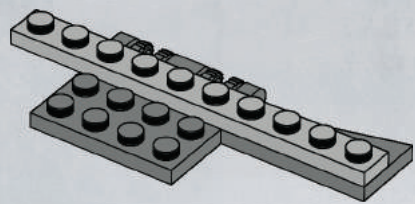

1x



1x

4

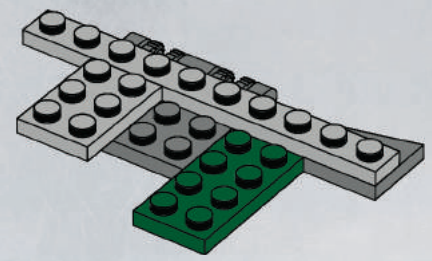

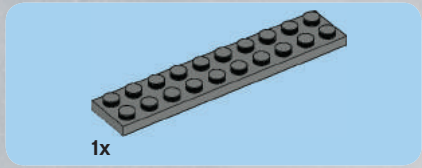

5

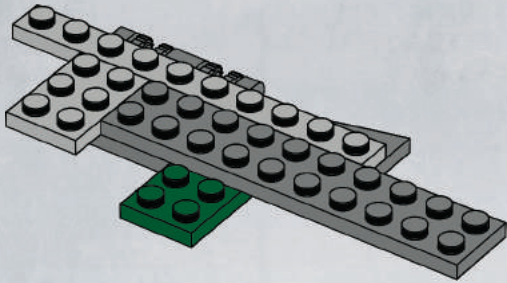

34

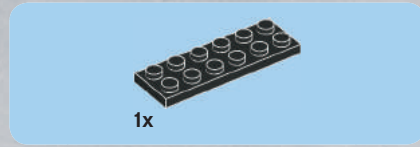

6

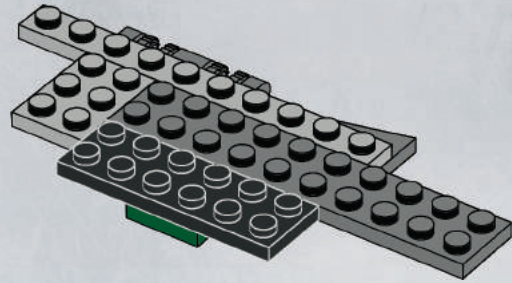

1x



1x



1x

7

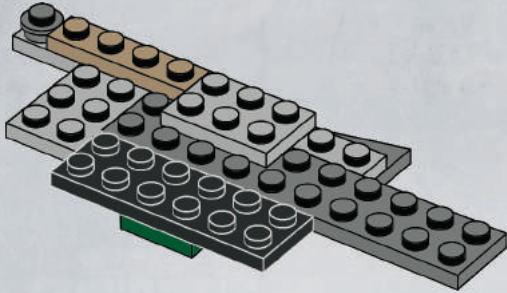

1x

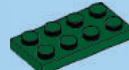

2x



1x



2x



8

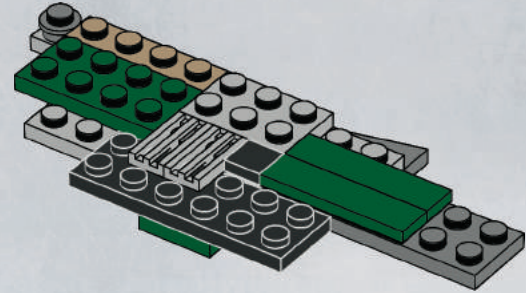

35



9

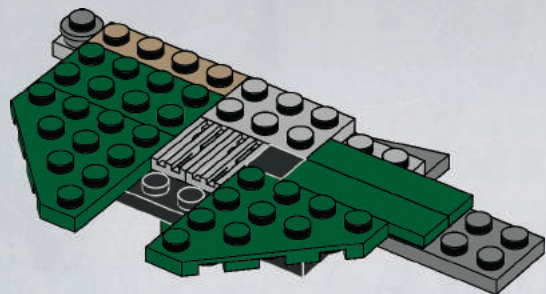

36



10

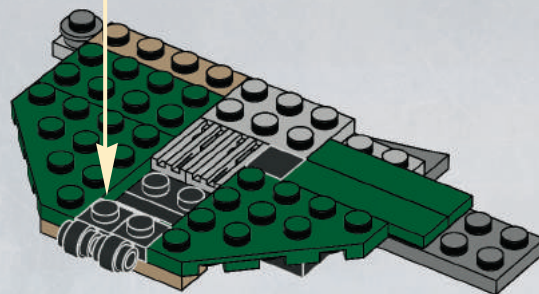
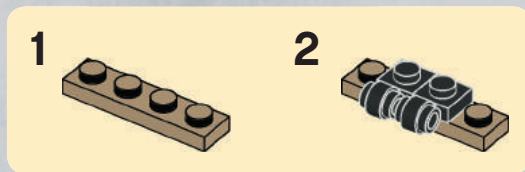

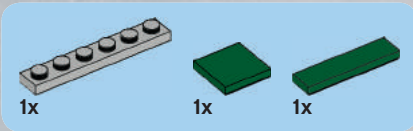

11

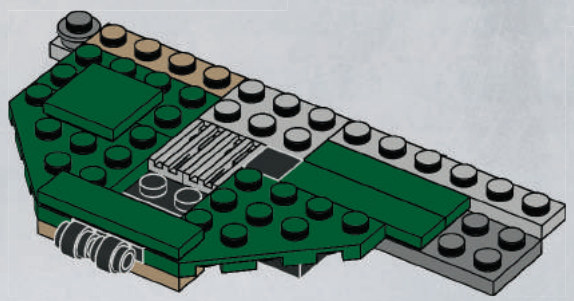

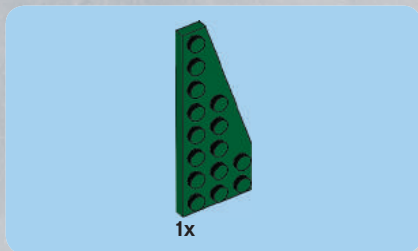

12

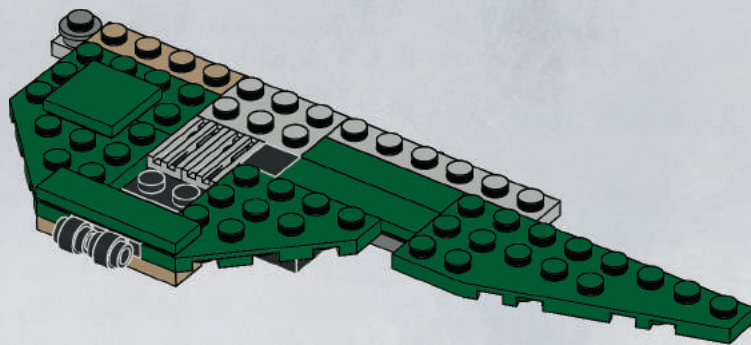

38

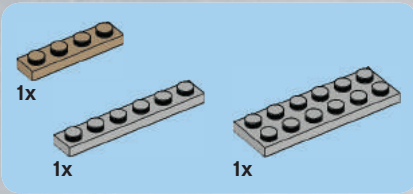

13

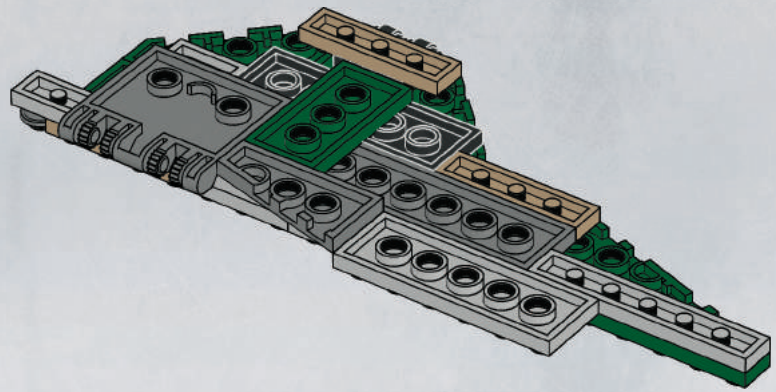





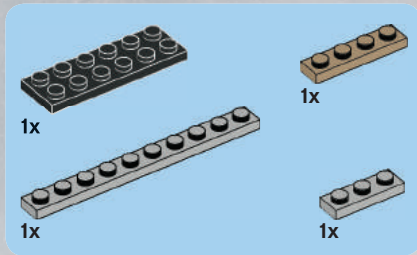

15

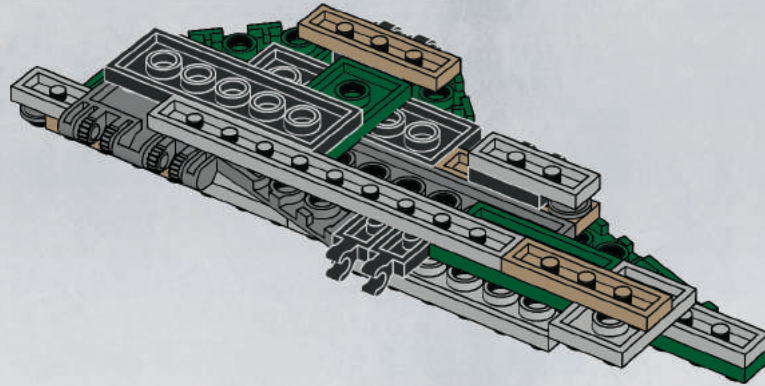

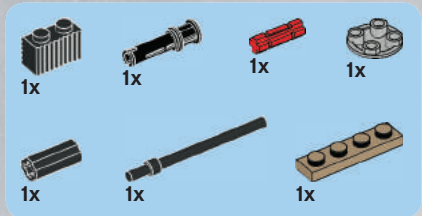

# 16

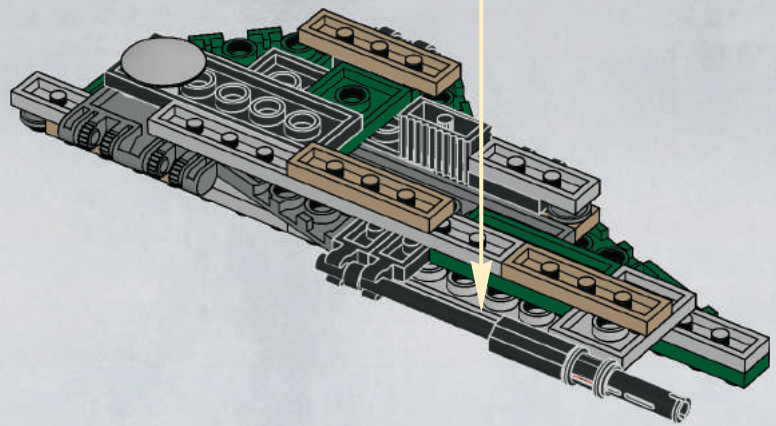
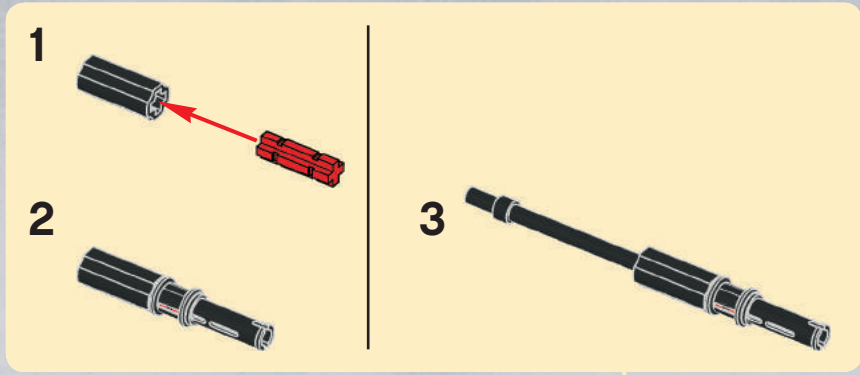

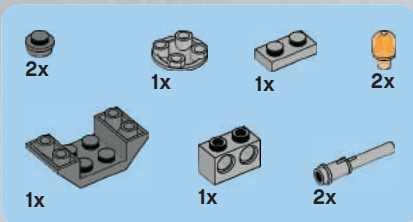

17

1

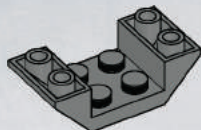

2

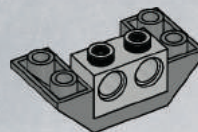

3

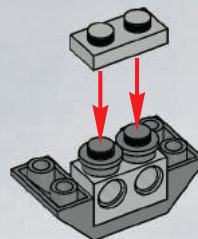

4

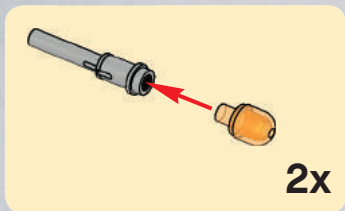
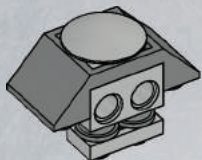

2x

5

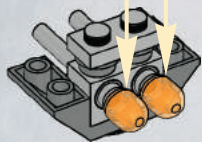

44

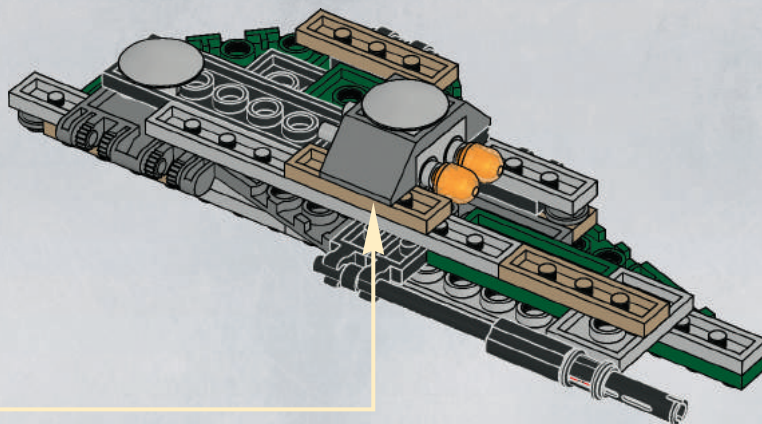

1x

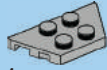

1x

# 18

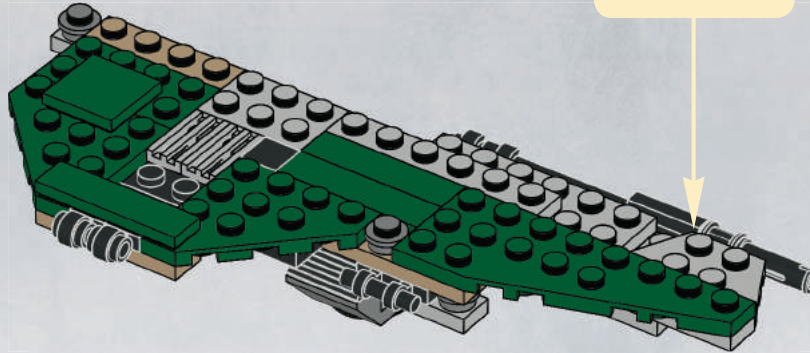
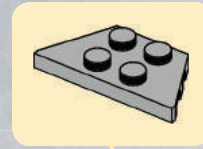

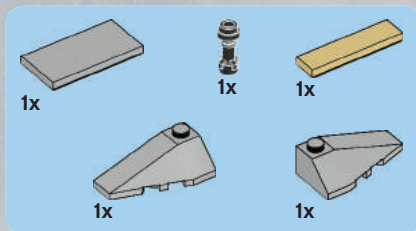

# 19

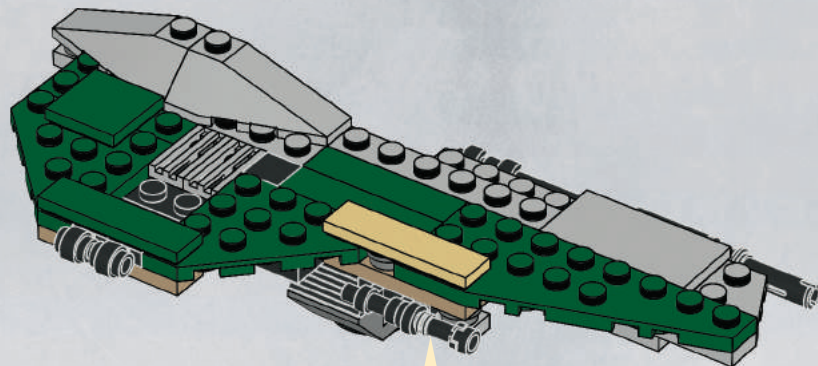

46



4x

# 20

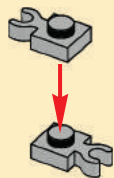

2x

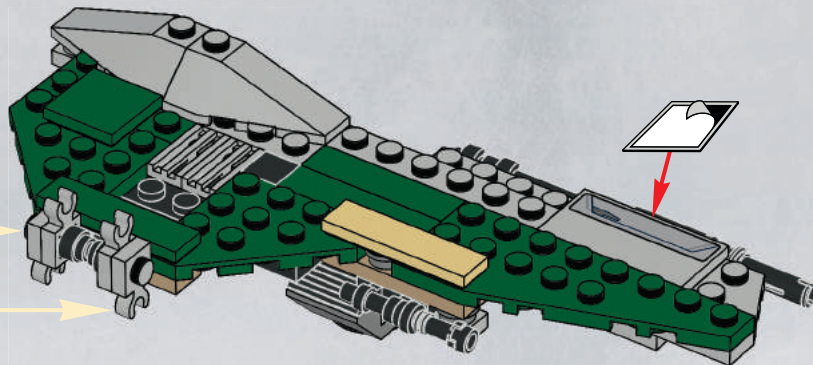

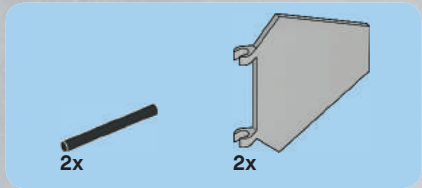

# 21

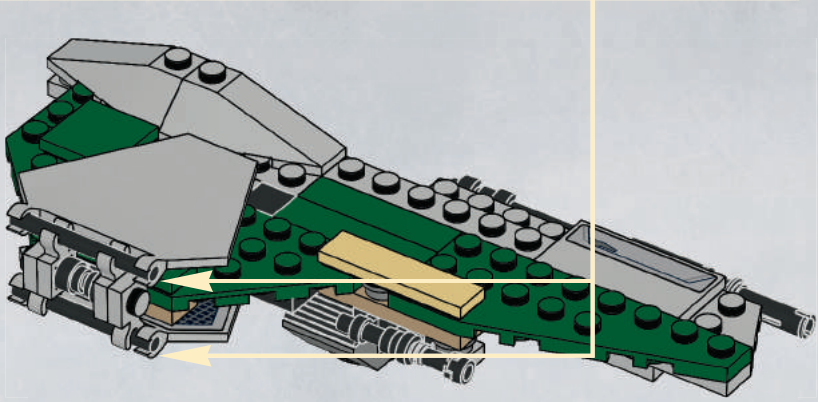
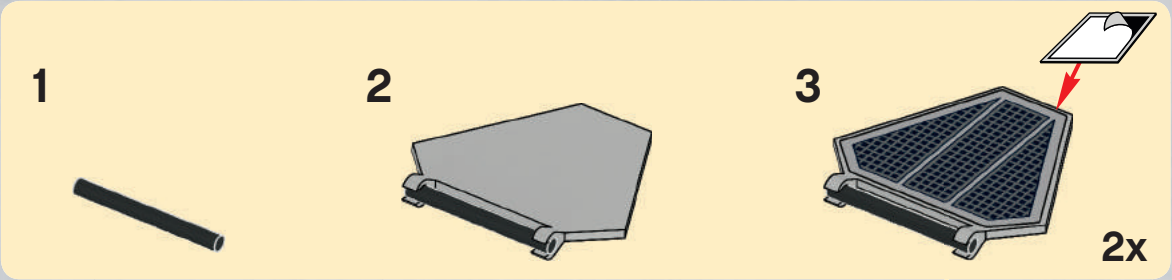



22

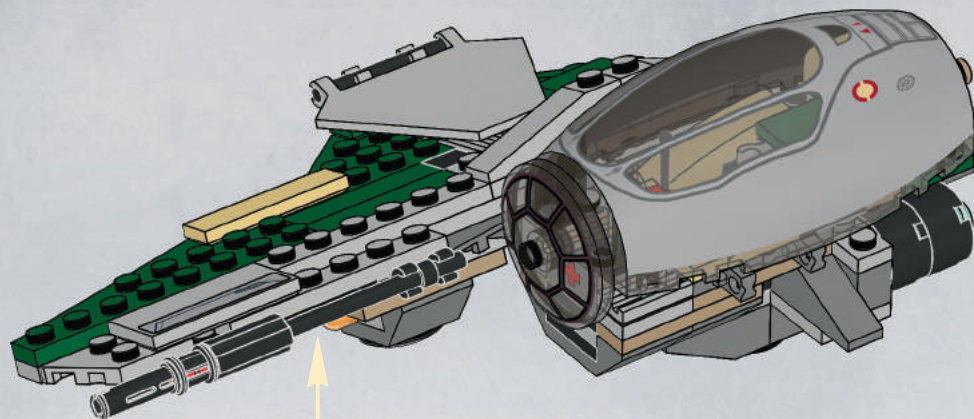

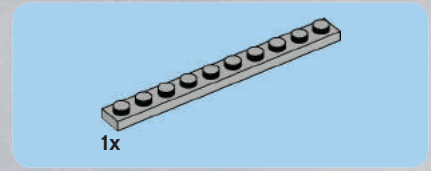
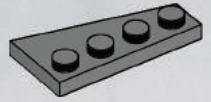
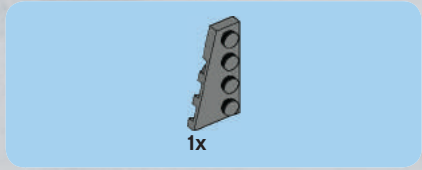
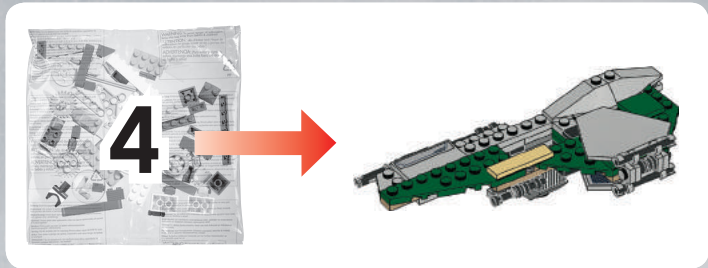

**2**

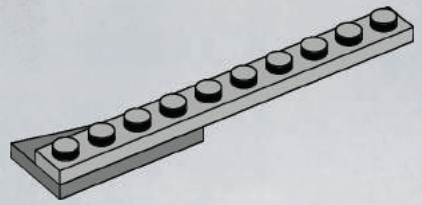



1x

3

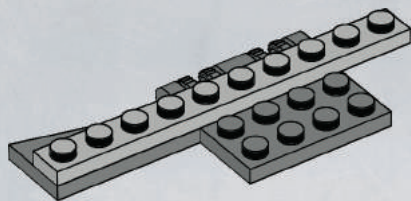

1x

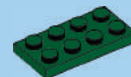

1x

4

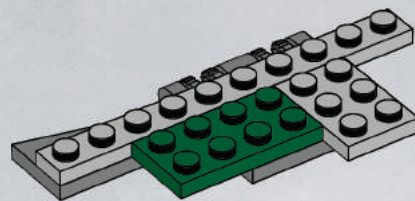



1x

5

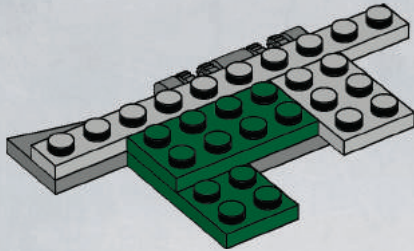

52

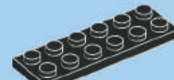

1x

6

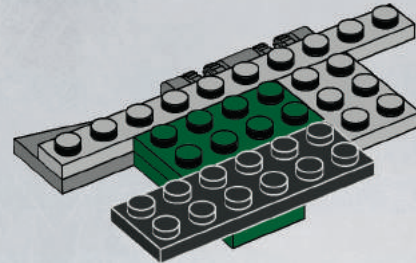

1x



1x



1x

# 7

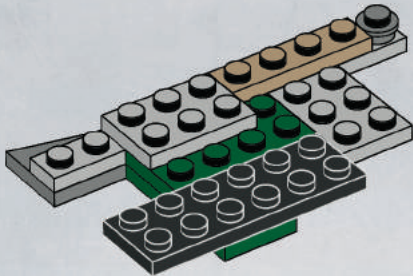

1x



2x



1x

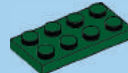

# 8

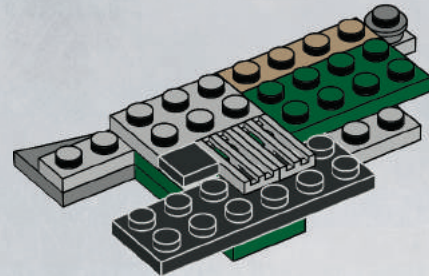



2x

# 9

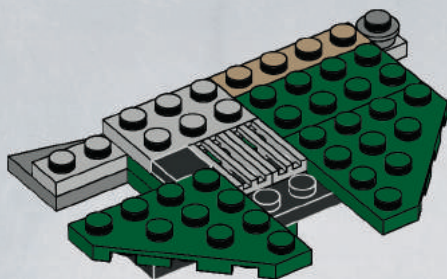

54



1x



2x

# 10

1

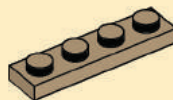

2

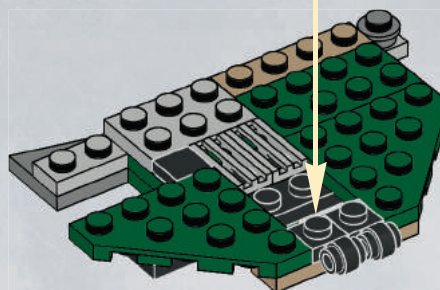
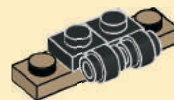

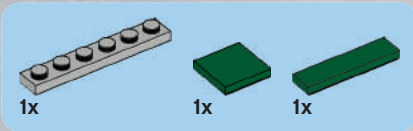

11

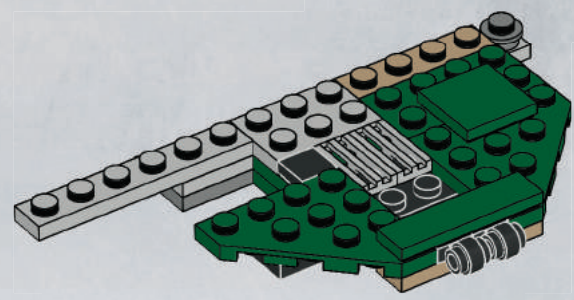

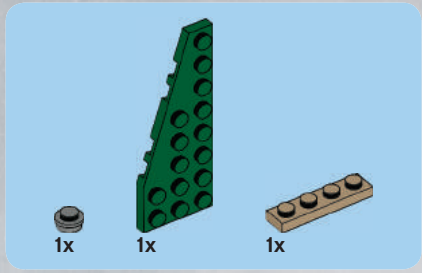

12

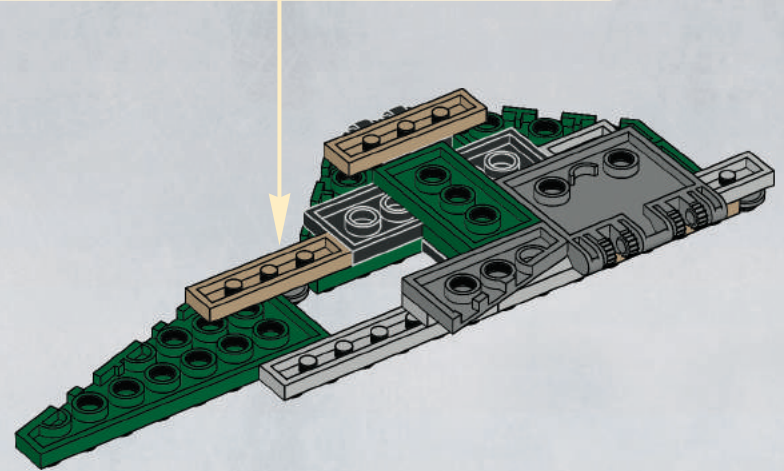
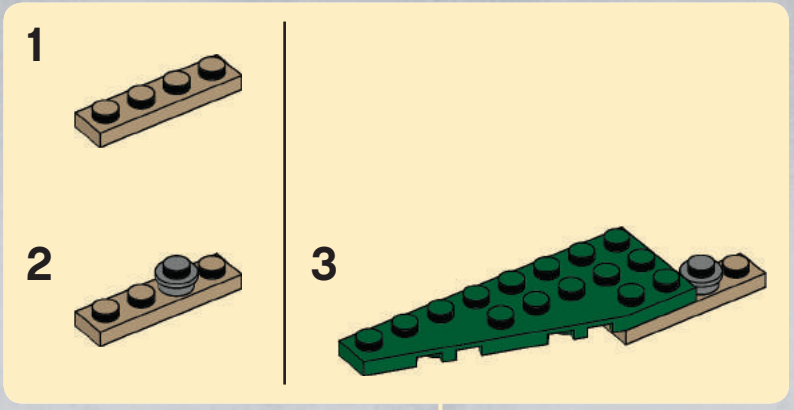





2x

# 13

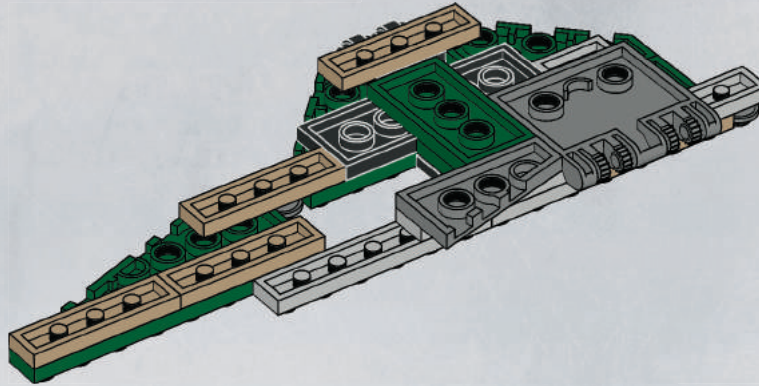

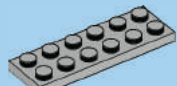

1x

# 14

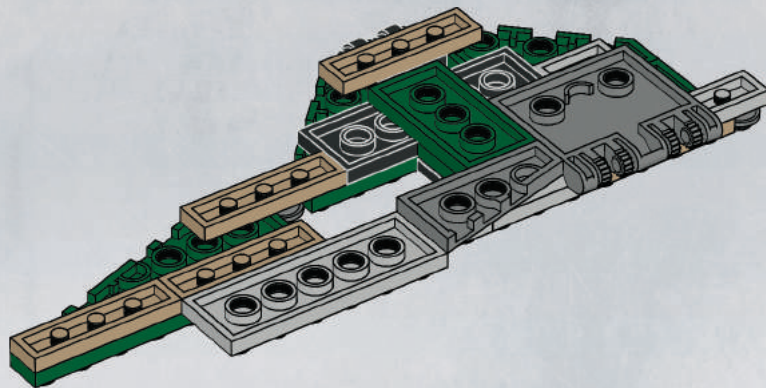

58

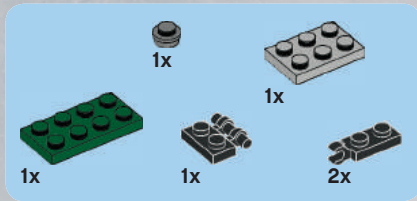

15

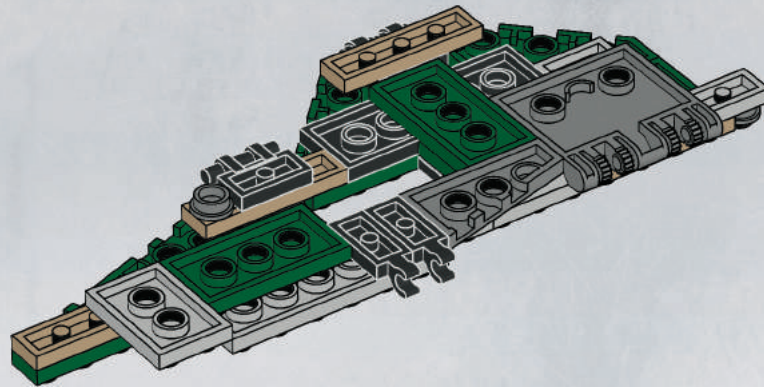

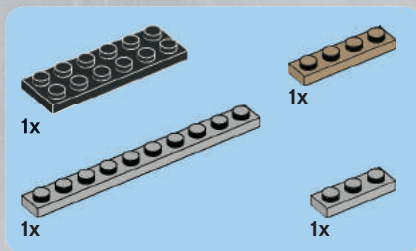

# 16

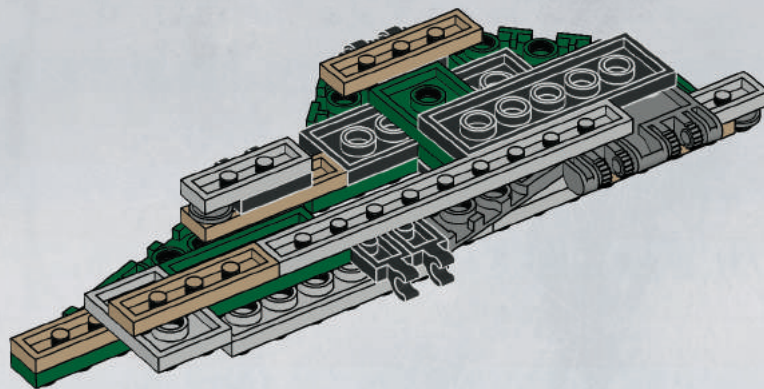

60

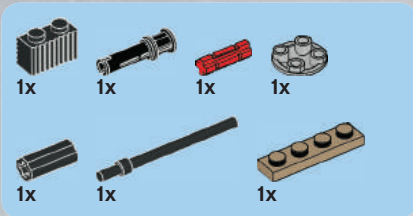

# 17

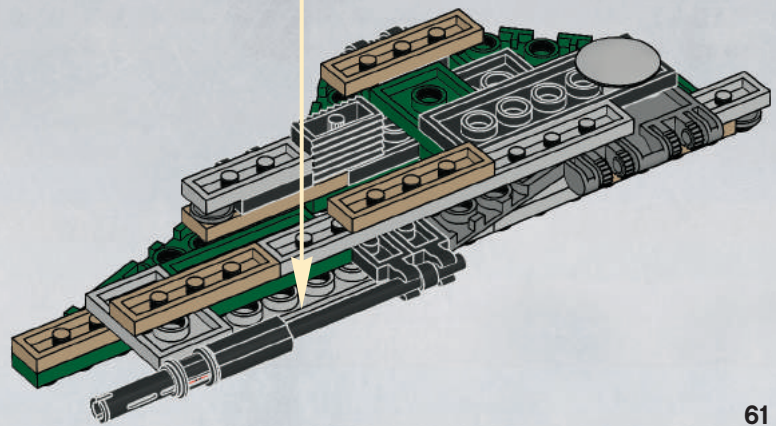
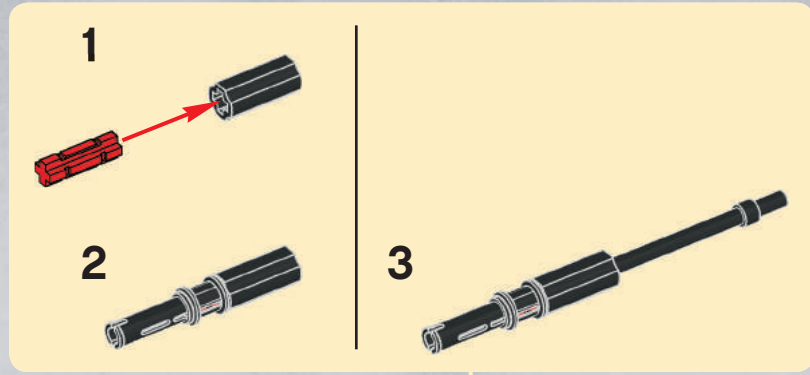

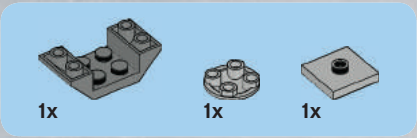

# 18

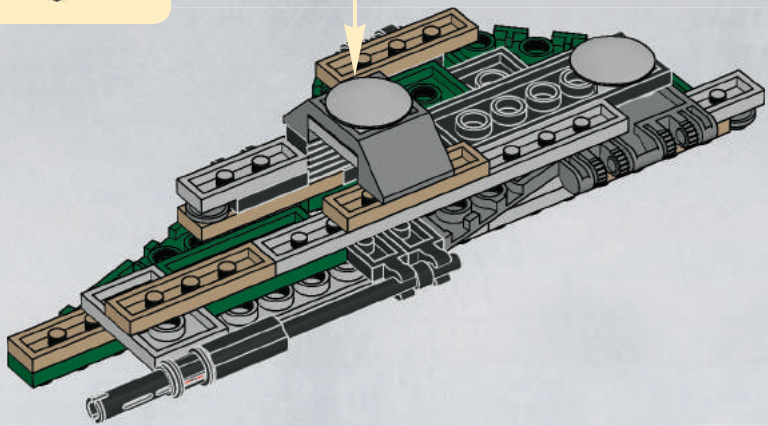
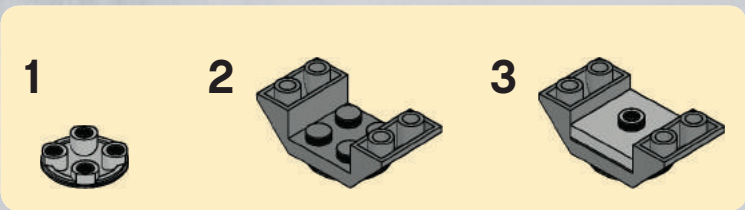

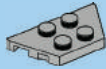

1x

# 19

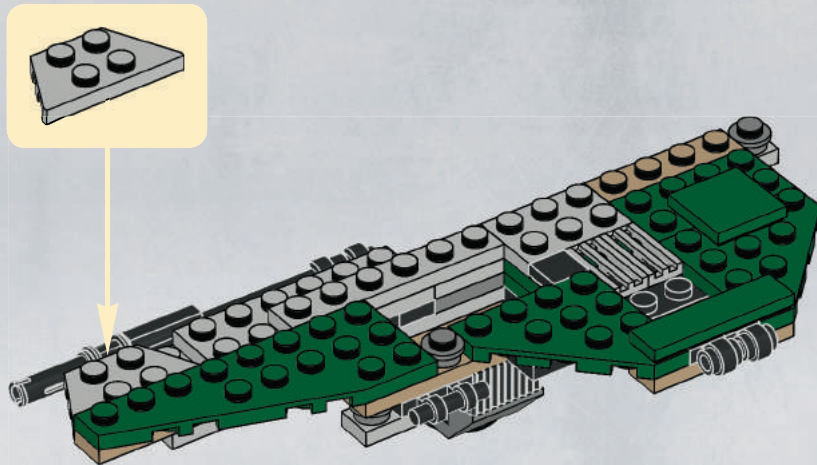

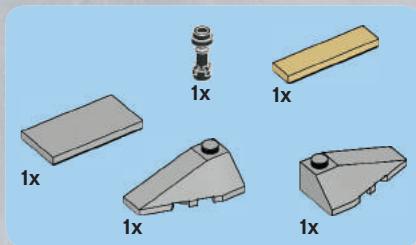

20

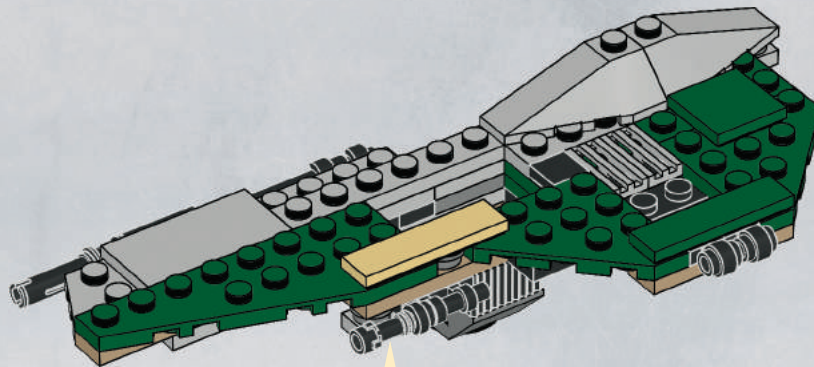

64





4x

# 21

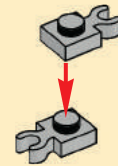
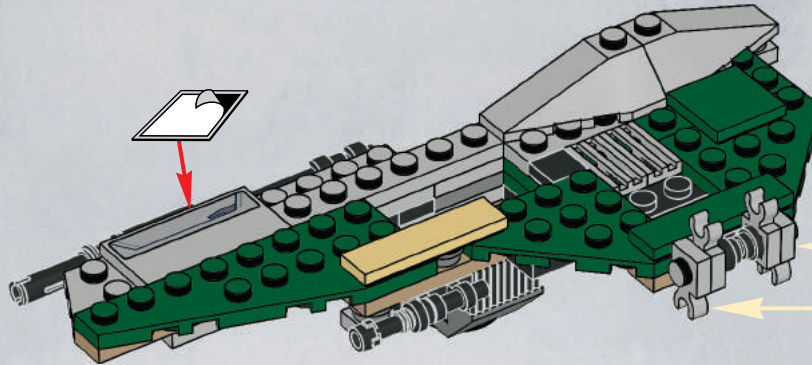

2x

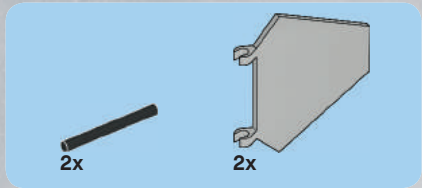

22

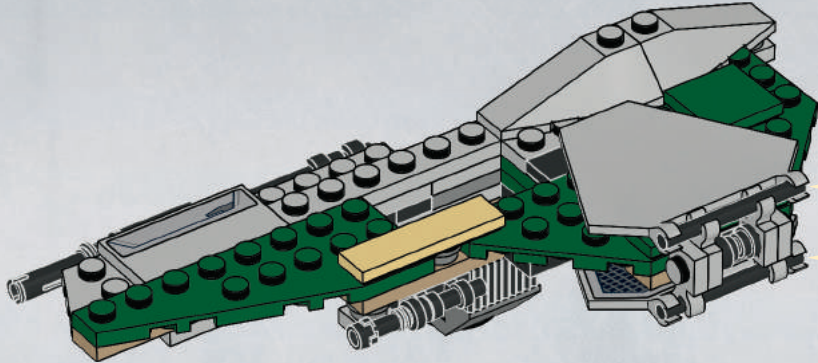
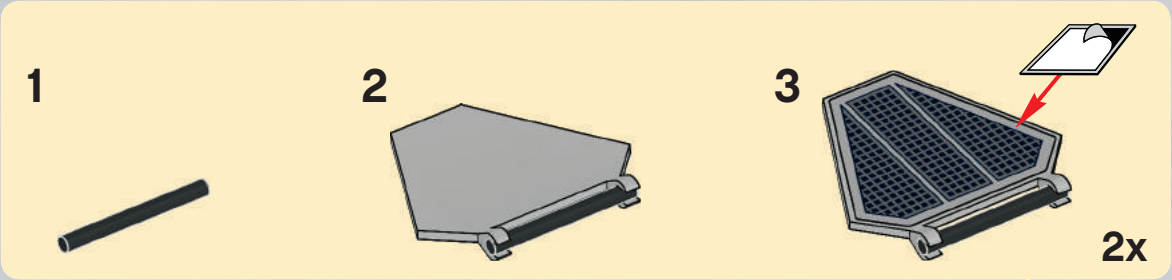

66

23

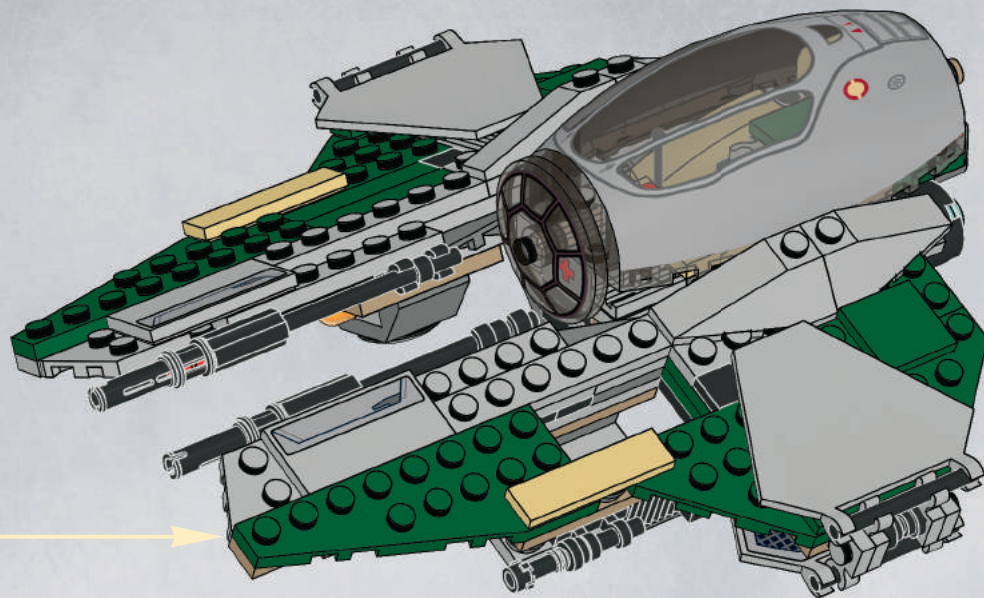

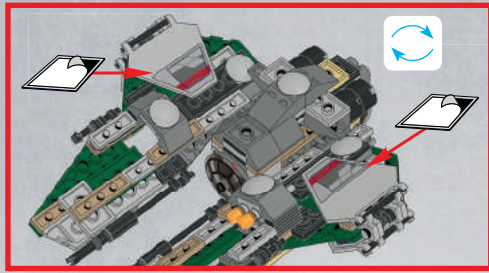

24

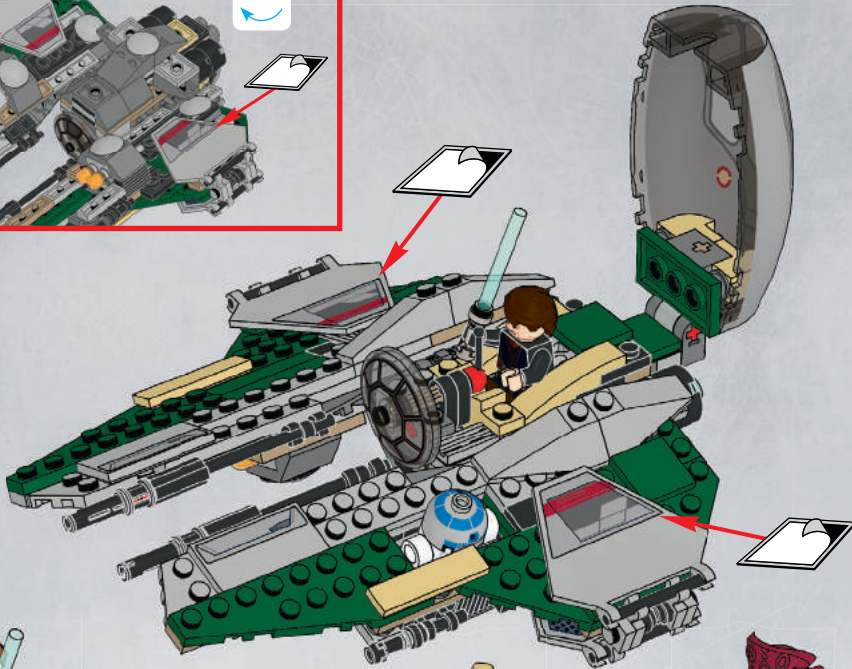

- 1x 4194011
- 2x 4124113
- 4x 255521
- 2x 4515348
- 1x 74335
- 4x 4142865
- 1x 4656150
- 1x 4656346
- 1x 4515350
- 1x 302126
- 4x 379526
- 1x 383226
- 2x 4538722
- 5x 4140303
- 1x 415026
- 4x 4632571
- 2x 4140588
- 4x 4535739
- 2x 4512363
- 2x 4164133
- 2x 307026
- 2x 4598897
- 1x 4498713
- 2x 4140801
- 2x 287726
- 4x 614326
- 4x 242026
- 7x 4225201

68



**Customer Service**  
**Kundenservice**  
**Service Consommateurs**  
**Servicio Al Consumidor**  
[www.lego.com/service](http://www.lego.com/service) or dial



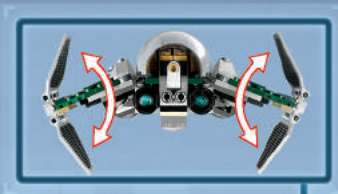

ANAKIN SKYWALKER™



NUTE GUNRAY™



Obi-WAN KENOBI™



SECURITY BATTLE DROID™



R2-D2™



9493



9492



9491



9490



9489



9488





# WIN!

Go to [www.LEGOsurvey.com/product](http://www.LEGOsurvey.com/product)  
to fill out a survey for a chance  
to win a cool LEGO® Product.

No purchase necessary.

Open to all residents where not prohibited.



## [www.LEGOsurvey.com/product](http://www.LEGOsurvey.com/product)

### GEWINNE!

Nimm an der Umfrage auf [www.LEGOsurvey.com/product](http://www.LEGOsurvey.com/product) teil und hab die Chance ein cooles LEGO® Produkt zu gewinnen!  
Die Teilnahme am Gewinnspiel führt zu keinerlei Kaufverpflichtungen. Teilnahme in allen nicht ausgeschlossenen Ländern möglich.

### WIN!

Ga naar [www.LEGOsurvey.com/product](http://www.LEGOsurvey.com/product), vul een enquêteformulier in en maak kans op een cool LEGO® product.  
Geen aankoopverplichting. Iedereen mag deelnemen, uitgezonderd ingezetenden van landen waar een enquêteverbod geldt.

### GAGNE!

Visite [www.LEGOsurvey.com/product](http://www.LEGOsurvey.com/product) pour répondre à un questionnaire et avoir une chance de gagner un produit LEGO® très cool!  
Aucune obligation d'achat.  
Ouvert à tous les résidents des pays autorisés.

### 当てよう!

[www.LEGOsurvey.com/product](http://www.LEGOsurvey.com/product) にアクセスして、アンケートにご記入ください。  
当選者にはレゴ®製品を差し上げます。  
お買い上げの必要はありません。  
禁止されていない限り、すべての皆様にご利用いただけます。



6006436 / 6006439

LEGO and the LEGO logo are trademarks of the/son des marques de commerce de/son marcas registradas de LEGO Group. ©2012 The LEGO Group.

© 2012 Lucasfilm Ltd. & TM. All rights reserved/Tous droits réservés. /Todos los derechos reservados.